

TRANSMETTEUR DE PRESSION HAUTE PRÉCISION

La compagnie Suisse Trafag AG est un fabricant international et spécialisée dans le développement et la fabrication des dispositifs de capteurs pour la mesure et la surveillance de la pression et de la température.



Applications

- Bancs d'essai
- Équipement de test

Avantages

- Précision jusqu'à 0.05 % E.M.
- Versions avec membrane frontale ou avec membrane affleurante
- Température du fluide jusqu'à 125°C
- Protection CEM, IEC 61000

Données techniques

Principe de mesure	Piézorésistif	Température de médias	-40°C ... +125°C
Plage de mesure	0 ... 0.1 à 0 ... 100 bar	Température ambiante	-40°C ... +125°C
Signal de sortie	4 ... 20 mA, 0 ... 5 VDC, 0 ... 10 VDC		

Information pour la commande/code de type

				8845 . XX			XX	XX	XX	XX	XX
Plage de mesure ¹⁾	Plage [bar]	Surpression [bar]	Pression d'éclatement [bar]	Plage [psi]	Surpression [psi]	Pression d'éclatement [psi]					
		0 ... 0.1	3	850	66	0 ... 1.5	40	12000	F6		
	0 ... 0.16	3	850	67	0 ... 2	40	12000	F7			
	0 ... 0.2	3	850	68	0 ... 2.5	40	12000	F8			
	0 ... 0.4	3	850	69	0 ... 5	40	12000	F9			
	0 ... 0.6	3	850	70	0 ... 7.5	40	12000	G0			
	0 ... 1	3	850	71	0 ... 15	40	12000	G1			
	0 ... 1.6	4.8	850	73	0 ... 20	60	12000	G3			
	0 ... 2.5	7.5	850	75	0 ... 30	100	12000	G5			
	0 ... 4	12	850	76	0 ... 50	150	12000	G6			
	0 ... 6	18	850	77	0 ... 100	250	12000	G7			
	0 ... 10	30	850	78	0 ... 150	400	12000	G8			
	0 ... 16	48	850	79	0 ... 250	600	12000	G9			
	0 ... 25	75	850	80	0 ... 400	1000	12000	H0			
	0 ... 40	120	850	81	0 ... 500	1700	12000	H1			
	0 ... 60	180	850	82	0 ... 1000	2500	12000	H2			
	0 ... 100	300	850	83	0 ... 1500	4000	12000	H3			
Capteur	Type O3 relative						P3				
	Type O3 absolue						A3				
Raccord de pression	1/4" NPT mâle						30				
	1/2" NPT mâle						39				
	G1/4" femelle						10				
	G1/4" mâle						15				
	G1/2" mâle						21				
	G1/2" mâle, membrane frontale						31				
	G1/2" mâle, membrane affleurante						32				
Connexion électrique	Embase mâle EN 175301-803-A (DIN43650-A)						05				
	Embase mâle: Binder 723, 5-pôle						14				
	Embase mâle MIL-C 26482, 10 - 6						02				
	Embase mâle M12x1, 4-pôle						32				
Signal de sortie	Signal de sortie	Résistance de charge		I (alimentation)		U (alimentation)					
	4 ... 20 mA	(Alimentation U - 9 V) / 20 mA				9 ... 33 VDC					19
	0 ... 5 VDC	≥ 10 kΩ		≤ 3 mA		10 ... 30 VDC					14
	0 ... 10 VDC	≥ 10 kΩ		≤ 3 mA		12 ... 30 VDC					17
Accessoires	Joint FKM, -18°C ... +125°C (Standard)						61				
	Joint EPDM, -40°C ... +125°C						63				
	Remplissage d'huile special: Anderol Food (pour applications alimentaires)						94				
	Fiche femelle EN 175301-803-A (DIN43650-A)						58				
	Fiche femelle Binder 723, 5-pôle, métal						37				
	Fiche femelle MIL-C 26482, 10 - 6, métal						32				
	Plage de température compensée -40°C ... +125°C						TA				
	Plage de température compensée -25°C ... +100°C						TB				
	Plage de température compensée 0°C ... +70°C						TC				
	Élément d'amortissement de pic de surpression ²⁾						DE				

¹⁾ Plages de pression à spécifier par le client sur demande

²⁾ Seulement avec raccord de pression 30, 39, 15, 21

Spécifications		
Spécifications électriques	Signal de sortie / Tension d'alimentation	4 ... 20 mA: 9 ... 33 VDC 0 ... 5 VDC: 10 ... 30 VDC 0 ... 10 VDC: 12 ... 30 VDC
	Sensibilité de montée	Typ. 1 ms / 10 ... 90 % pression nominale
Conditions d'environnement	Température de médias	-40°C ... +125°C
	Température ambiante	-40°C ... +125°C
	Protection ¹⁾	Min. IP40
	Vibration	EN 60068-2-6: 10 g (4...2000 Hz)
	Choc	EN 60068-2-27: 100 g/ 6 ms
CEM protection	Emission	EN 61000-4-3: 10 V/m
	Immunité	IEC 61000-4-2: 8 kV contact/15 kV air
Spécifications mécaniques	Capteur (en contact avec les médias)	1.4435 (AISI316L)
	Raccord de pression (en contact avec les médias)	1.4435 (AISI316L)
	Boîtier	1.4435 (AISI316L)
	Joint	FKM 70 Sh / EPDM
	Embase mâle	Voir information pour la commande
	Poids	~ 220 g
	Couple de serrage	max. 30 Nm

¹⁾ Valable seulement avec fiche femelle montée selon instructions

Précision			
Plage de mesure de pression	[bar]	0.1 ... < 1.0	0 ... 1 à 0 ... 100
NLH @ +25°C (BSL par 0)	[% E.M. max.]	± 0.1	± 0.05
TEB @ 0 ... +70°C ²⁾	[% E.M. typ.]	± 0.2	± 0.15
	[% E.M. max.]	± 0.4	± 0.3
TEB @ -25 ... +100°C ²⁾	[% E.M. typ.]	± 0.3	± 0.2
	[% E.M. max.]	± 0.5	± 0.4
TEB @ -40 ... +125°C ²⁾	[% E.M. typ.]	± 0.4	± 0.3
	[% E.M. max.]	± 0.7	± 0.6
Stabilité à long terme 1 année	typ.	< 1 mbar	< 0.1 % E.M.
	max.	< 2 mbar	< 0.2 % E.M.

²⁾ Erreur globale y compris déviation de la ligne caractéristique et erreur de température en cas de marge de signal maximale

Dimensions

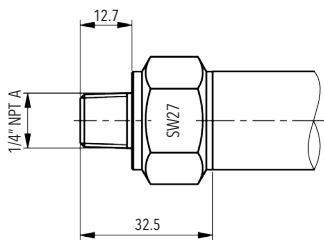

8845.XX.XX30.XX.XX.XX
 > 25 bar

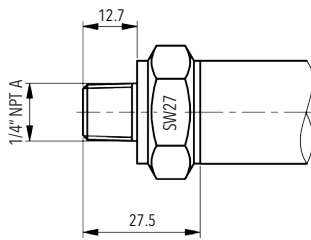

8845.XX.XX30.XX.XX.XX
 ≤ 25 bar

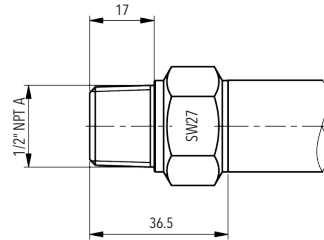

8845.XX.XX39.XX.XX.XX
 > 25 bar

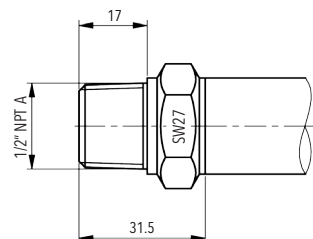

8845.XX.XX39.XX.XX.XX
 ≤ 25 bar

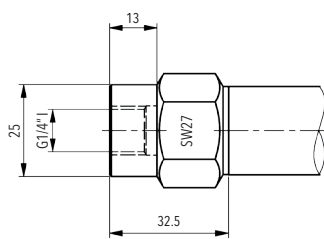

8845.XX.XX10.XX.XX.XX
 > 25 bar

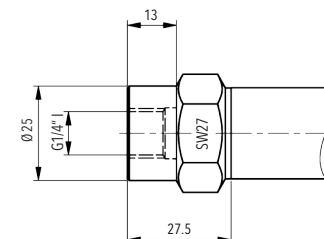

8845.XX.XX10.XX.XX.XX
 ≤ 25 bar

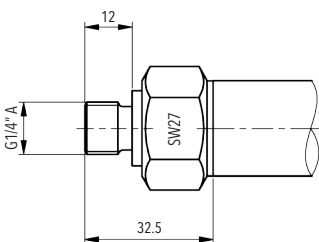

8845.XX.XX15.XX.XX.XX
 > 25 bar

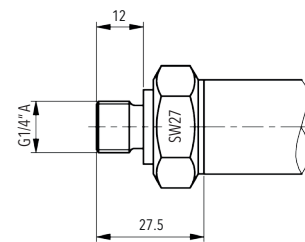

8845.XX.XX15.XX.XX.XX
 ≤ 25 bar

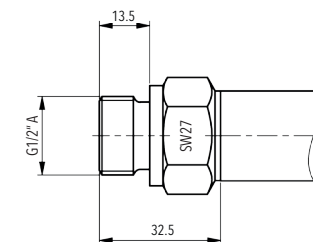

8845.XX.XX21.XX.XX.XX
 > 25 bar

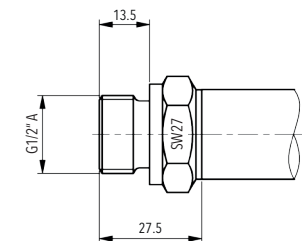

8845.XX.XX21.XX.XX.XX
 ≤ 25 bar

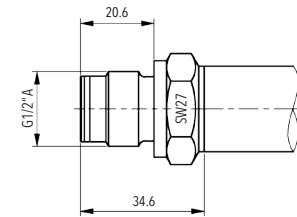

8845.XX.XX31.XX.XX.XX

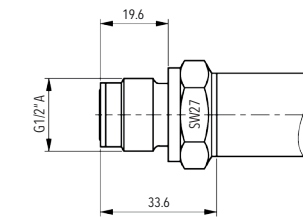

8845.XX.XX32.XX.XX.XX

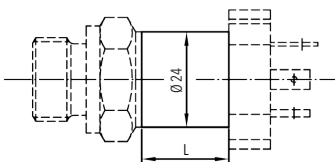

8845.XX.XXXX.XX.XX.TA
8845.XX.XXXX.XX.XX.TB
8845.XX.XXXX.XX.XX.TC

Connexion électrique

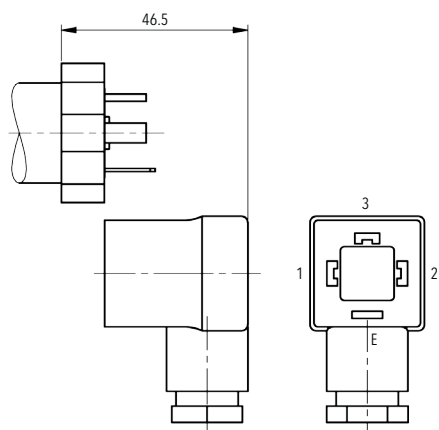

8845.XX.XXXX.05.XX.58

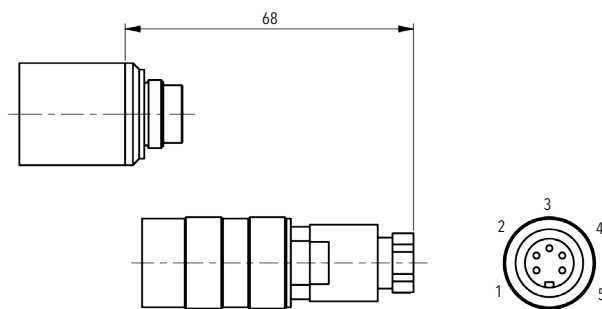

8845.XX.XXXX.14.XX.37

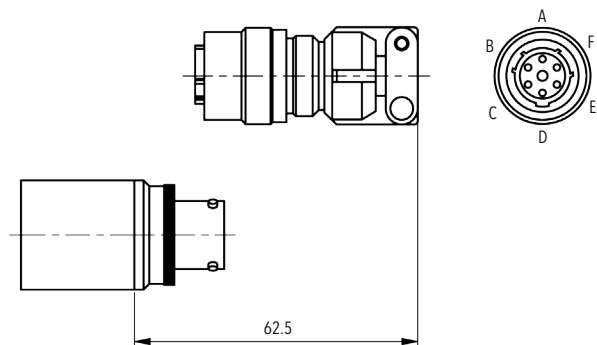

8845.XX.XXXX.02.XX.32

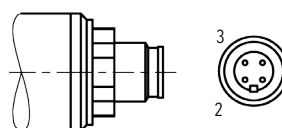

8845.XX.XXXX.32.XX.XX

Connexion électrique

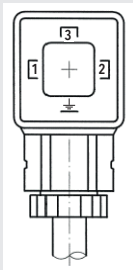
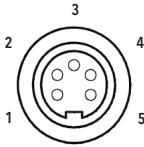
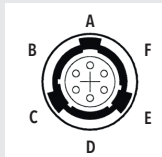
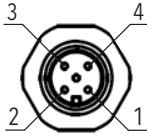
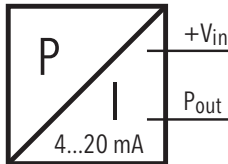
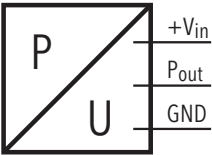
		Protection / connexion électrique			
		IP65	IP67	IP40	IP67
		Standard Industriel EN175301-803A (DIN43650)	Binder 723 5-pôle	MIL-C 26482 10 - 6	M12x1 4-pôle
		05 *	14 *	02 *	32 *
					
Signal de sortie	 8845.xx.xxxx.xx.19	1	3	A	4
	 8845.xx.xxxx.xx.14/17	1	3	A	4
		2	1	C	3
		3	4	B	1

* Vue sur fiche femelle

Erweiterte Informationen

Dokumente

Datenblatt	www.trafag.com/H72354
Betriebsanleitung	www.trafag.com/H73227
Flyer	www.trafag.com/H70609